

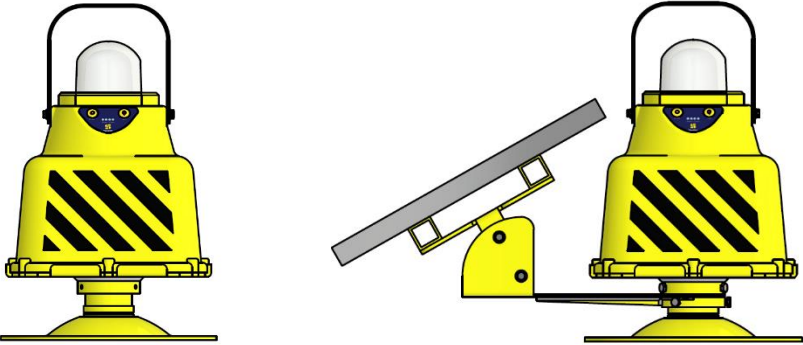



Polaris Threshold Wing HI V1

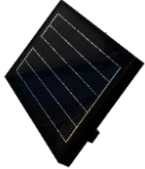

<p>Compliance to standards</p>	<p>ICAO: International Civil Aviation Organization, Airports, Annex 14, Vol. 1</p> <p>IEC TS 61827: Electrical installations for the lighting and signaling of aerodromes. Characteristics of recessed and raised luminaires used at aerodromes and heliports.</p>
<p>Application</p>	<p>Battery-powered Directional GREEN LED lights indicating the threshold of the Airport runway.</p> <p>High intensity lights, according ICAO.</p> <p>The POLARIS design has been done in such way as to provide maximum safety.</p> <p>It is a reliable and flexible product, being easy to fit into any kind of infrastructure.</p>
<p>Features</p>	<p>Designed and built with simplicity and ease of maintenance in mind. High power LED technology (100 000 hrs lifespan). IRLED - optional. Lightweight, low-energy and environment friendly lighting fitting. Lead Acid battery</p> <p>Operating modes: Steady with brightness control 1%, 3%, 10%, 30% and 100% Local/manual control Battery status LEDs Optional: working only during the night with photocell control Optional: Radio control one or two way Optional: GPS incorporated Optional: Activated by ARCAL – pilot activation</p>

<p>Product Code</p>	<p>AL-162-06-GR</p> <p>Series Indicator (Airfield Lighting) AL Product Indicator 162 LEDs Number 06 LEDs Light Color (Green) GR</p> <p>Optional: IR LED IR</p> <p>Example of ordering codes: AL-162-06-GR AL-162-07-GR-IR (when IR is included the number of LEDs are 7)</p>
<p>Description</p>	<p>Housing - powder coated aluminum RAL 1004 (aviation yellow) </p> <p>Disperser - hardened glass</p> <p>Cable gland - nickel plated brass</p> <p>Fasteners - stainless steel</p> <p>Casing - polycarbonate UV resistant</p> <p>Carrying handle - aluminum</p> <p>Light fixtures are provided with anti-condensation valve.</p>
<p>Environment</p>	<p>Temperature range: - 55° to +55°</p> <p>Degree of protection: IP 68</p> <p>Humidity: 0-100%</p>
<p>Mounting</p>	<p>The device can be installed directly on the ground, on a frangible support or on a frangible support + solar panel.</p> 

<p>Electrical Characteristics</p>	<p>Power consumption: maximum 8W powered at 100% brightness</p> <p>Power supply: Power supply is provided by rechargeable Lead Acid battery 12V - 12 Ah</p> <p>Solar panel: minimum 20W, optional 30 or 40W</p> <p>Autonomy under ideal conditions (new battery, fully charged at 100%, external temperature of 20° Celsius)</p> <p>Brightness level:</p> <ul style="list-style-type: none"> 100% - 18 hrs 30% - 60hrs 10% - 180hrs 3% - 600hrs 1% - 1800hrs
<p>Charging</p>	<p>Charging and be done through various methods, depending on the selected connectivity, as detailed below:</p> <ol style="list-style-type: none"> <p>Charging Pads - By using charging pads, the lamps can be charged with:</p> <div style="display: flex; justify-content: space-around;"> <div style="text-align: center;"> <p>Drop-in Tray</p>  </div> <div style="text-align: center;"> <p>Rack (5/10/15/20 lamps)</p>  </div> </div> <p>DC charging - By using the DC port, the lamps can be charged with:</p> <div style="display: flex; justify-content: space-around;"> <div style="text-align: center;"> <p>External Solar Panel</p>  </div> <div style="text-align: center;"> <p>Individual Charger (1/6/10 lamps)</p>  </div> </div>

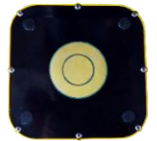

Charging

3. **AC charging** - By using the AC port, the lamps can be charged with:



Integrated charger via a cable

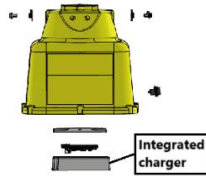

220V Rack



4. **Built-in solar panel**

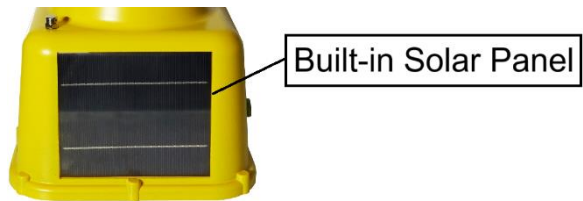

**Local/manual
Control**

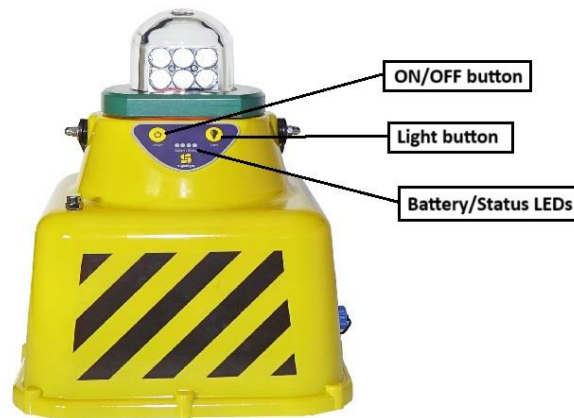

After mechanical installation is done, push the ON/OFF button. This will connect the battery and the POLARIS unit will be powered. As long as the unit is powered the yellow LED from the SIGNALIGHT LOGO will flash every 5 seconds. In this moment the lights are in STANDBY mode.

To start the MAIN LEDs push the "Light button". At the first push the battery level will be indicated with the signal LEDs:

- First LED ON means the battery is between 0 to 25 % charged
- First two LEDs ON means the battery is between 25 to 50 % charged
- Three LEDs ON means the battery is between 50 to 75 % charged
- All four LEDs ON means the battery is between 75 to 100 % charged

The battery level indication expires in about 10 seconds and the status LEDs will turn OFF.

If the "Light button" will be pushed again MAIN LEDs will turn ON at 1%, after another push will go to 3%, then to 10%, 30% and 100%. After another push the light will turn OFF and the POLARIS unit will go in STANDBY.

Disconnecting the battery

If the "Light button" is pressed for longer than 3 seconds the battery will be disconnected. This operation is recommended if the lamps are going to be stored for a longer period of time or during transport. In this stage the consumption is zero. When the Polaris is disconnected, the main LEDs will flash for 3 times.

Control of the lamps can be done locally using the buttons on the control panel of the lamps or via the control application.

LOCAL CONTROL

All lamps have a control panel that includes two buttons and four signaling LEDs. Additionally, there is an orange LED in the middle of the LOGO SIGNALIGHT symbol.

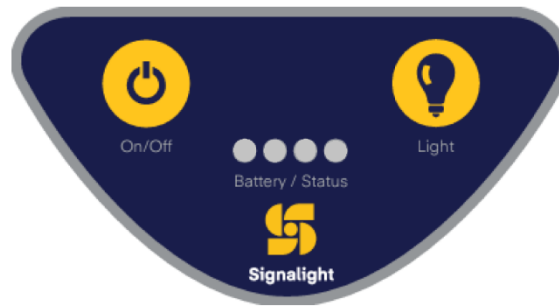

After installation, pressing the On/Off button closes the power circuit between the battery and the lamp.
After pressing the button, the first LED of the battery status will light up:



At this moment, the lamp requests access to the system. After a few seconds, the lamp receives access to the system, at which point the third LED will light up:



Radio control

From this moment on, the lamp can also be controlled via the application. Locally, the "Light button" can be pressed. Upon the first press, the battery level can be viewed:

Battery Charged 75-100%	Battery Charged 50-75%	Battery Charged 25-50%	Battery Charged 0-25%
----------------------------	---------------------------	---------------------------	--------------------------



On the second press, the lamp turns on at 1%. With another press, it turns on at 3%, then at 10%, then at 30%, and finally at 100%. If pressed again, the lamp turns off.

If the "Light button" is held down for more than 5 seconds, the lamp will flash three times and then turn off (disconnecting the power from the battery).

To restart it, the On/Off button must be pressed.

Optional the POLARIS lights can be radio controlled.

Radio control is made using LORA technology in 868 Mhz for Europe or 915 Mhz for US, optional 433 Mhz.

The lights can be controlled one way using a handled remote control.



One way communications means all the lights can be started at 1%, 3%, 10%, 30% or 100% or switched OFF.

Optionally, the lamps can be controlled in groups, pre-set at the factory through a customized remote control

Another option is to control the lights using a base station, in this case the communication is bidirectional via POLARIS application.

The distance covered can be up to 10 km in line of sight.

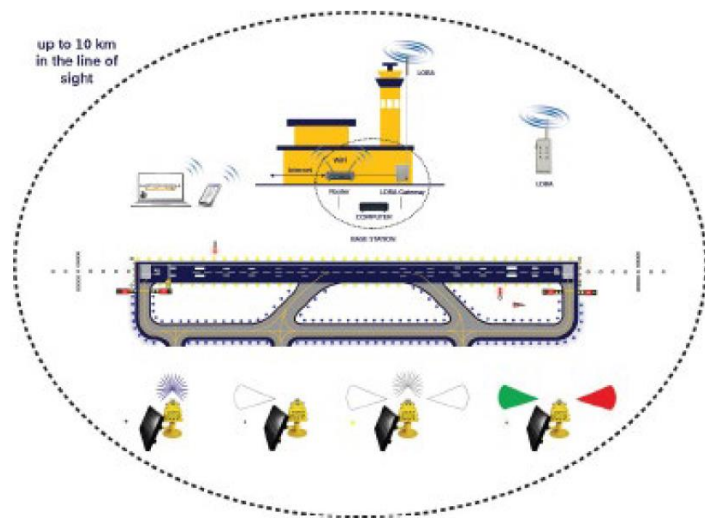

From the POLARIS application the control is more complex. The lights can be controlled individual, in groups, on scenarios and the user can see all the parameters of the lights.

ARCAL – Pilot activation



This option allows pilots to activate the lights using the communication system. If you click three times on the microphone, the lamps will work at 10%, after five clicks, the lamps will work at 30% of intensity, and after 7 clicks, the lamps will work at 100%.

Mechanical
Characteristics

Width: 236.5 mm
Total height: 277.5 mm
Weight: 6.5 kg

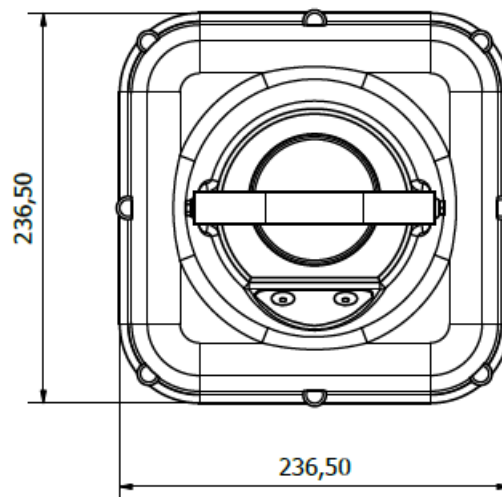
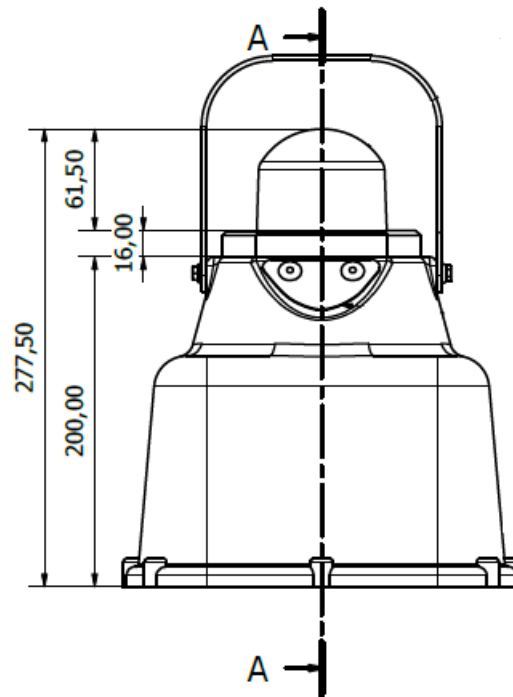

Photometric Characteristics

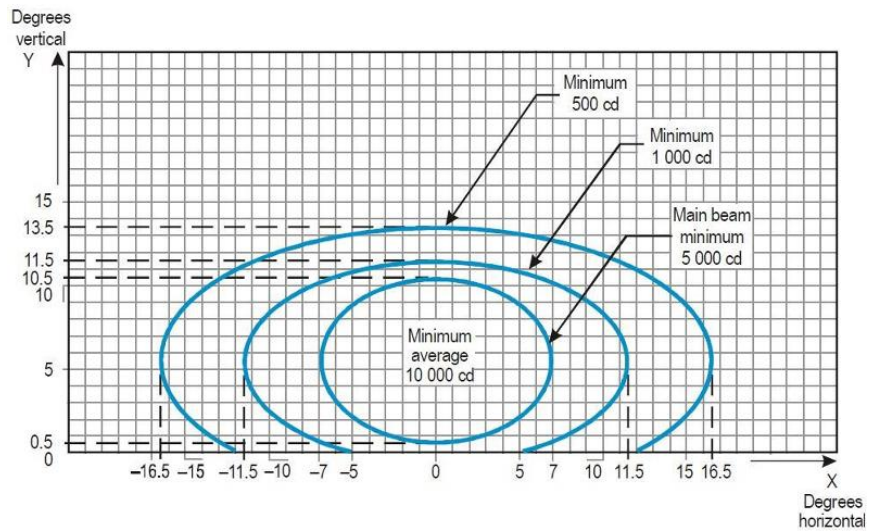

ICAO requirements Annex 14 Vol.1 Fig. A2-4.

High intensity: 100%

Average main beam 10 000cd

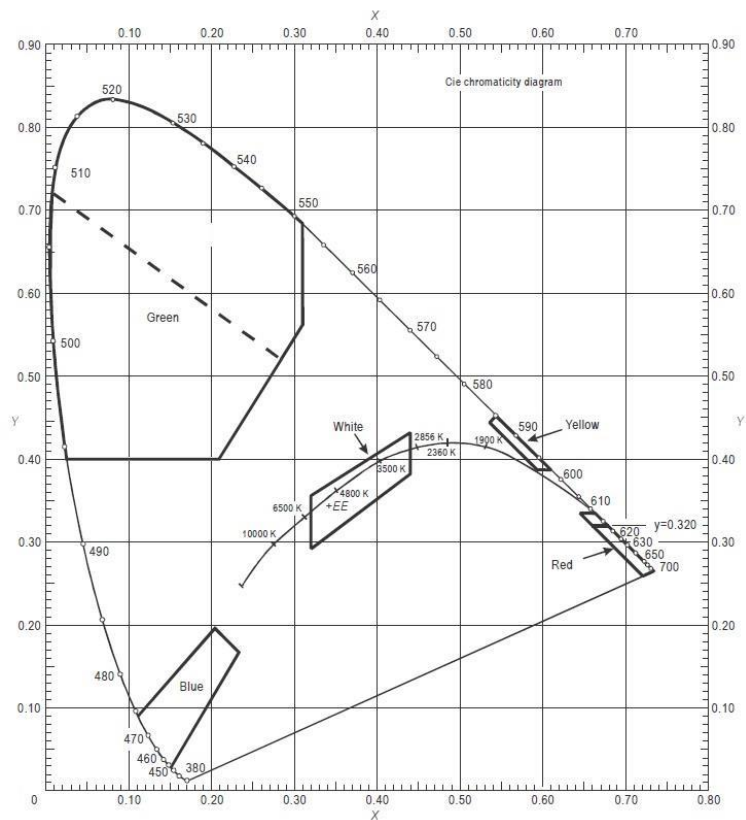

The measured trichromatic coordinates correspond to colour range requirements in:

ICAO Annex 14 – Aerodromes Vol.1, ig, A1-1b. Colours for aeronautical ground lights (solid state lighting)



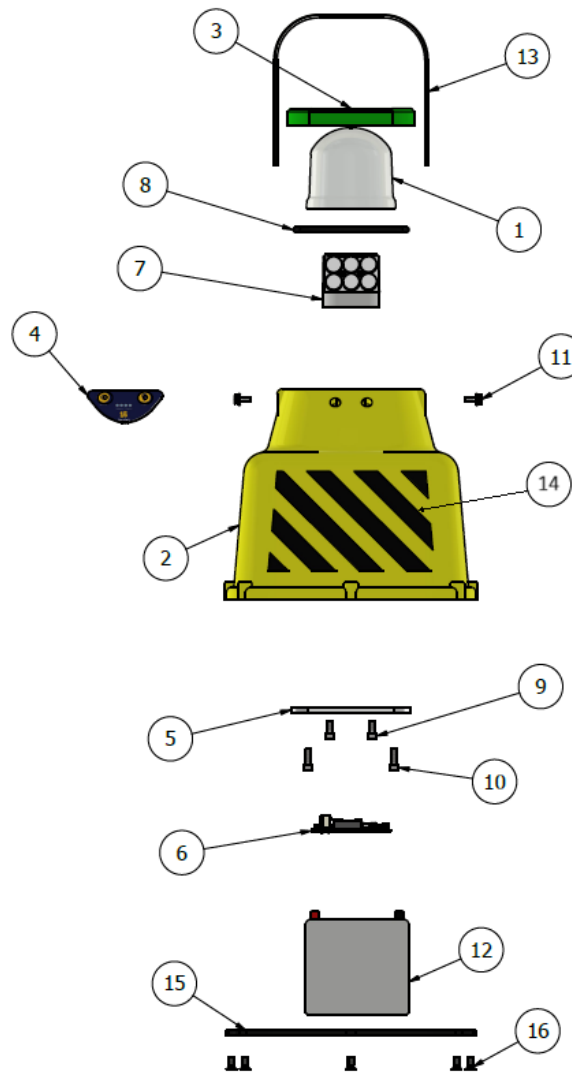





Spare Parts

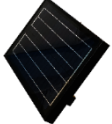

- 1. Glass Disperser
- 2. Polycarbonate Casing
- 3. Mounting Flange
- 4. Control Panel
- 5. Optical Assembly Support
- 6. Electronic Assembly
- 8. Rubber Gasket
- 9. M5 x 12 Screw
- 10. M5 x 16 Screw
- 11. M5 x 10 Bolt
- 12. Battery
- 13. Handle
- 14. Sticker
- 15. Cover
- 16. M5 x 12 Flat Head Screw

Accessory

To order accessories please call our customer support. For contact details please refer to our website - www.signalight.com

#	NAME - SERIES	PRODUCT CODE	IMAGE
1	Polaris Solar panel stand	AL-123-AX	
2	Polaris base plate	AL-124-AX	
3	Drop-in charger	AL-125-AX	
4	Drop-in rack	AL-126-XX-AX	
5	Polaris – Photo Voltaic Panel	AL-141-AX	
6	Polaris Remote Control	AL-165-AX	
7	Charger for Polaris	AL-199-XX-AX	
8	Polaris Base Station	AL-159-AX	



Signalight

+40 254 515 465
office@signalight.com

36 Lunca Street, Petrosani,
Hunedoara County, Romania

www.signalight.com